

# WALL TO STEEL CONNECTION #4

(DATE: 11-11-2014)

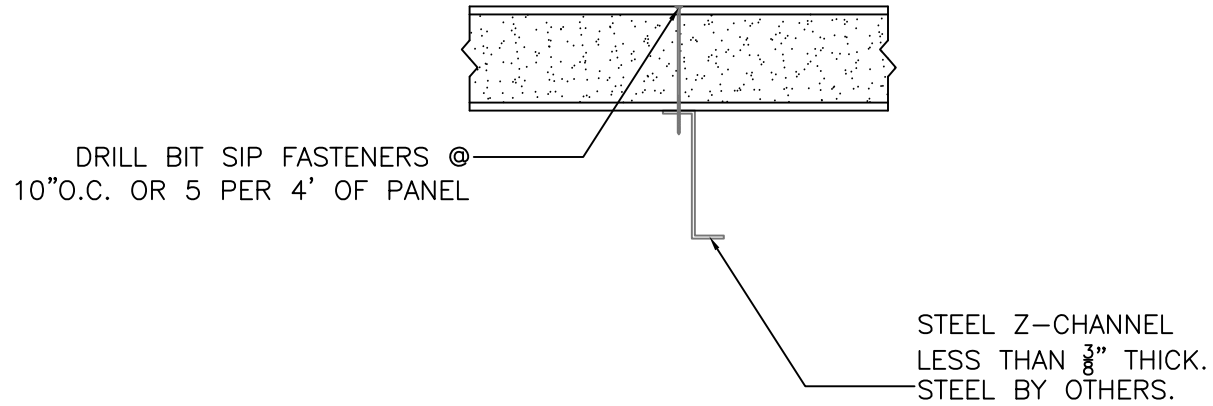

WALL TO STEEL CONNECTION - TYPE #4  
SCALE: 1" = 1'-0"

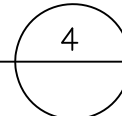

**Foard**  
P A N E L  
i n c o r p o r a t e d  
P.O. Box 185, West Chesterfield, NH 03466  
(603) 256-8800