

#46

TRUSS CONNECTION DETAIL

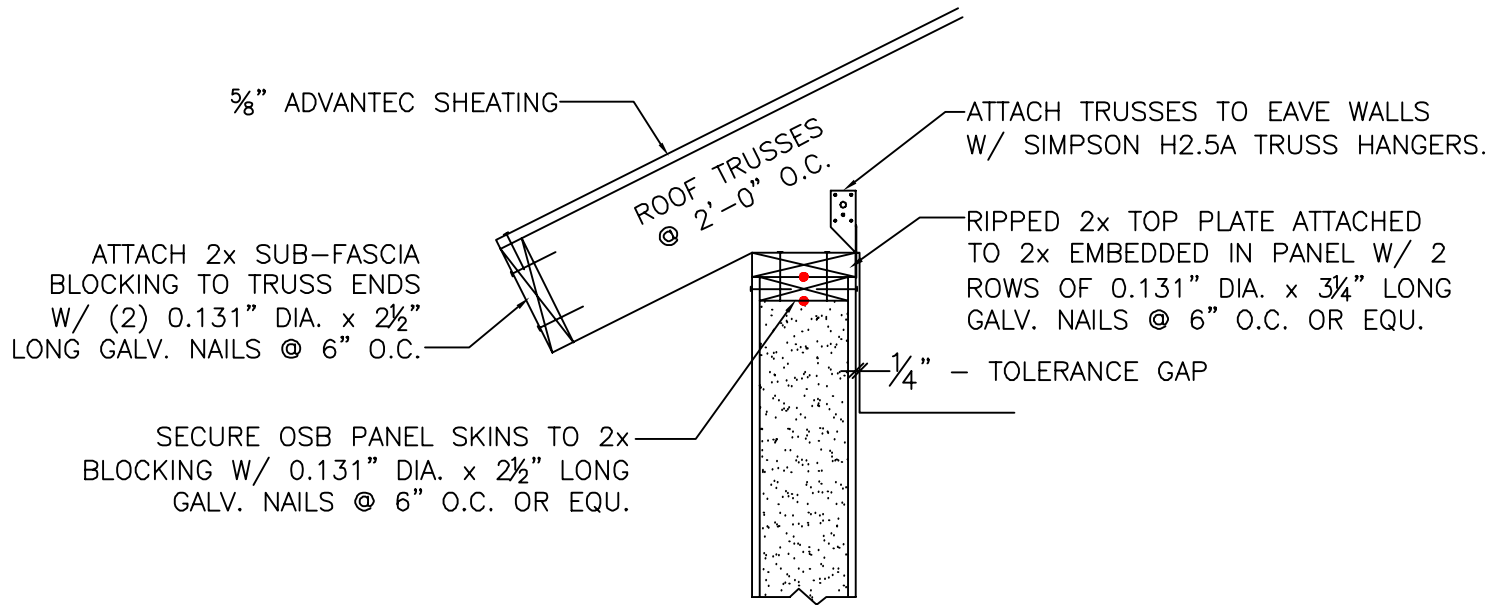

NOTE: ALL RED DOTS - APPLY CONTINUOUS
3/8" DIA. BEAD OF MASTIC SEALANT
BETWEEN 2x MEMBER & PANEL FOAM.

TRUSS CONNECTION DETAIL
SCALE: 1" = 1'-0"

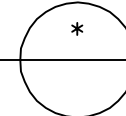

Foard
P A N E L
i n c o r p o r a t e d
P.O. Box 185, West Chesterfield, NH 0346
(603) 256-8800